



BOBAT

LADIES CORPORATE & HIGH FASHION MANUFACTURERS

CONTACT DETAILS

1st floor, Bobat Centre
38 Carlisle Street
Durban, 4001

Tel: +27 31 309 4089 • +27 31 309 7368

Fax: +27 31 309 2700

admin@bobatwholesalers.co.za

iyb@bobatwholesalers.co.za

sales@bobatwholesalers.co.za

www.bobatwholesalers.co.za

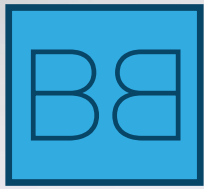

BOBAT

LADIES CORPORATE & HIGH FASHION MANUFACTURERS



CATALOGUE

SPECIALISTS IN LADIES CORPORATE WEAR & HIGH FASHION

Visit Our Website

download our digital catalogue

www.bobatwholesalers.co.za

AGENT STAMP

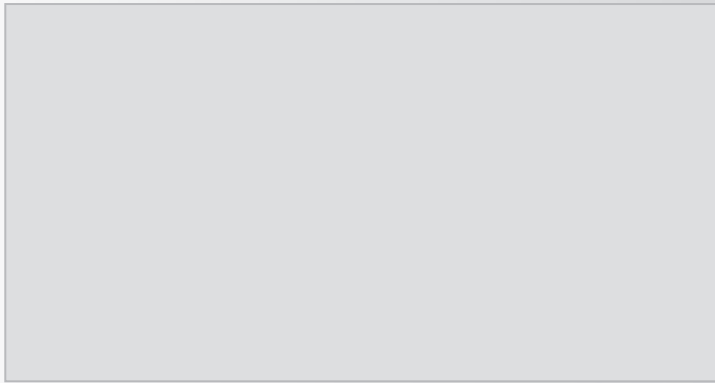

Request our full
digital catalogue
by visiting
www.bobatwholesalers.co.za

1st floor, Bobat Centre
38 Carlisle Street, Durban, 4001
Tel: +27 31 309 4089
+27 31 309 7368
Fax: +27 31 309 2700
admin@bobatwholesalers.co.za
iyb@bobatwholesalers.co.za
sales@bobatwholesalers.co.za
www.bobatwholesalers.co.za



WHAT ARE WE ABOUT?

We are an experienced Ladies Corporate, Nurse Wear and High Fashion design house. Having been in the industry since 1977 and with over 35 years experience we come highly recommended.

Bobat's pride itself on delivering clothing of the highest quality, made from only the best textiles. We are industry professionals, with an incomparable commitment to service excellence and customer satisfaction. When we design our clothes we bear in mind that each individual is unique and that what may work for one, may not necessarily work for another. Our business to the South African market is built around customising our design offerings instead of working on straight clothing order lines. Our designers are able to create and modify according to the needs of all our clients.

We are certainly the preferred choice within the industry as we understand the need to be flexible in an environment such as ours. We understand what it means to be ahead of the trends, we understand what it means to deliver on what we promise and most importantly we understand the need to deliver trusted and quality garments everytime.

Contact Details

1st Floor Bobat Centre, 38 Carlisle Street, Durban, 4001

Tel: +27 31 309 4089 / +27 31 309 7368 • Fax: +27 31 309 2700

e-mail: admin@bobatwholesalers.co.za / iyb@bobatwholesalers.co.za / sales@bobatwholesalers.co.za

www.bobatwholesalers.co.za



BOBAT specialises in manufacturing of ladies corporate wear for businesses

EXCLUSIVITY

At Bobat's we offer garments that are exclusively designed, fitting professionally and transforming all wardrobes into fashion forward ones. You can rest assured knowing the garment you choose will be one-of-a kind, tailor made just for you.

COST EFFECTIVE

We supply our garments at the best price possible as we are committed to providing quality garments at budget friendly prices so as to ensure all individuals are able to experience a Bobat garment. We strive to achieve excellence in quality at affordable prices.

QUALITY SERVICE

Our service is unparalleled and the quality of our goods undeniable. We continue to strive everyday to deliver innovative service delivery ideas to ensure we stay a cut above the rest.

How to Order

Step 1 Request a Price List

Contact a friendly consultant or your BOBAT agent directly (if you already have one) and request a price list. This will be sent to you via fax or email, depending on your preference.

Step 2 Fill Out the Order Form

Make a photocopy of the Order Form and Terms & Conditions found at the back of this catalogue. Ensure that all required details are filled out, and that the Terms & Conditions document is signed by an authorised signatory.

Step 5 Order Capturing

Your order will be captured and checked by our sales department. When it is confirmed that there are no garment queries, your order will be forwarded to our debtors department for approval.

Step 6 Manufacture

Once approved by our debtors department, your order will be sent to our factory and your garments will be manufactured.



Step 3 Send Your Order

Fax or email your signed forms and Terms & Conditions to us:

Fax: +27 31 309 2700

Email: sales@bobatwholesalers.co.za / iyb@bobatwholesalers.co.za
admin@bobatwholesalers.co.za

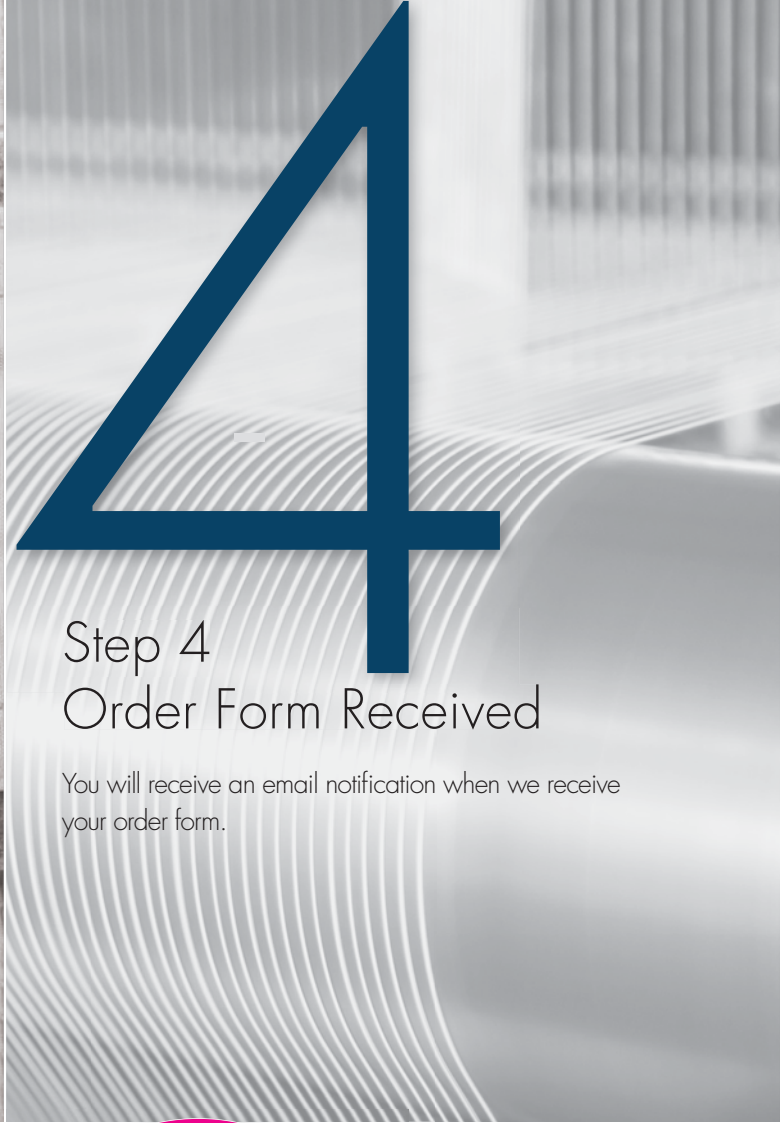

Step 4 Order Form Received

You will receive an email notification when we receive your order form.



Step 7 Packed & Ready

You will be notified when your order is ready so that you may complete your order payment.



Step 8 Delivery

Once payment is approved by our debtors department, your order will be ready for collection.

BLOUSES MEAN BUSINESS



B610 - FASHION BLOUSE

3/4 Sleeve Button Front
Blouse with Functional
Pockets.

E64 - BEST FIT PANTS

Extended Waistband Pants with
Pockets

SLIM FIT SHIRTS



SLIM FIT SHIRT



B965 - Button Front 3/4 Sleeve Shirt

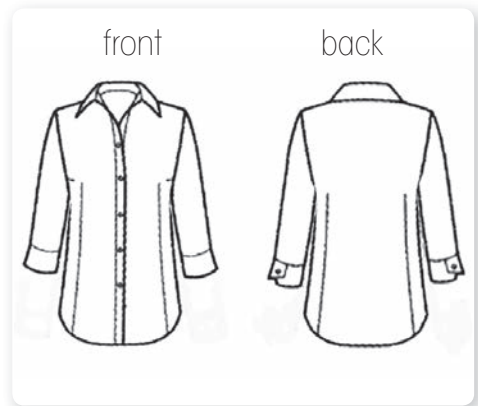

AVAILABLE IN VARIOUS PLAIN COLOURS. SEE SWATCH GUIDE.

NYLON STRIPED SHIRTS

RELAXED

B860 - RUCHED DETAIL BLOUSE
3/4 Sleeve Button-front, Long Length
Shirt with Side Slits

front

back



RELAXED

B620 - LONG LENGTH BLOUSE
3/4 Sleeve Oversize Shirt with
Side Slits

front

back



AVAILABLE IN VARIOUS STRIPES. SEE SWATCH GUIDE.





FITTED

B220 - EMPIRE LINE SHIRT
3/4 Sleeve Bias Fronting Shirt

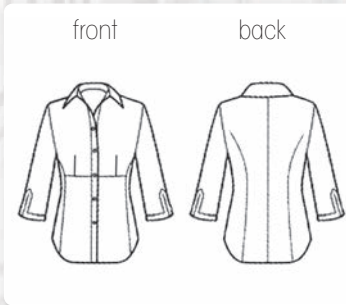

CLASSIC

B405 - BUTTON FRONT BLOUSE
Button Front 3/4 Sleeve Shirt



CLASSIC

B56 - FASHION BLOUSE
3/4 Sleeve Blouse with Plackard Detail



Our
BEST SELLER
Superior Quality
Spandex Lining

CLASSIC

B610 - FASHION BLOUSE

3/4 Sleeve Button front Blouse
with Functional Pockets.



front

back

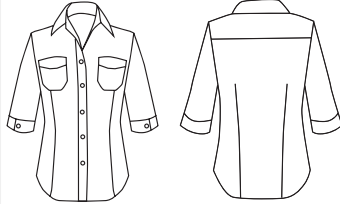

CLASSIC

B1008 - TIE-UP COLLAR BLOUSE

Short Sleeve, Blouse with Tie-up
detail



front

back

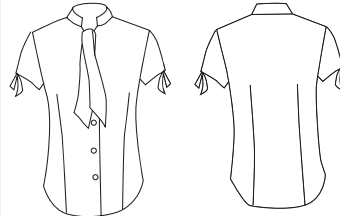

PRINTED CLASSIC BLOUSES

B405 - BUTTON FRONT BLOUSE

Button Front 3/4 Sleeve Blouse



front

back



AVAILABLE IN VARIOUS CORPORATE PRINTS

COTTON RICH BLOUSES



J235 - FASHION JACKET

One Button Long Sleeve Jacket,
with Mock Pockets

B402 - BUTTON FRONT BLOUSE

Long Sleeve Stripe Shirt

E64 - EXTENDED WAISTBAND

PANTS

Extended, Waistband Pants
with Pockets



B56 - FASHION BLOUSE

3/4 Sleeve Blouse with
Placket Detail

C238 - PENCIL SKIRT

Pencil line knee length skirt
with back vent including belt

STYLES FOR SUCCESS



WORK HARD DRESS SMART

J365 - BASIC JACKET

1/2 Lined Long sleeve,
Medium length Jacket with
mock pockets

B220 - EMPIRE LINE SHIRT

3/4 Sleeve Blouse
with Bias Fronting

E60 - PIN-TUCK PANTS

Two Pocket, Button Front Pants
with Waistband details and
Pin Tucks

SPANDEX SUITING JACKETS



FITTED

J370 - SHAPED JACKET
One Button Long sleeve
Shaped Jacket, Hip length
with mock pockets

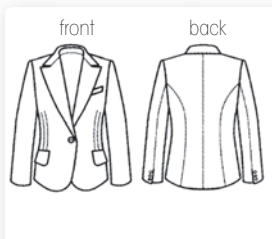

FITTED

J525 - LINED JACKET
Lined cuffs, Two Button
Fashion Jacket, with 2 mock
pockets, 1/2 lined body

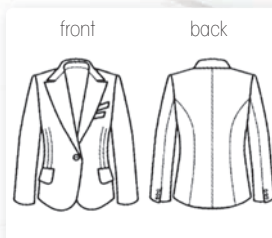

CLASSIC

J405 - COMFORT JACKET
Two Button Long sleeve
jacket, 1/2 lined with mock
pockets. Longer Length



JACKETS



CLASSIC

J365 - BASIC JACKET

1/2 Lined Long sleeve Medium Length Jacket with Mock Pockets.

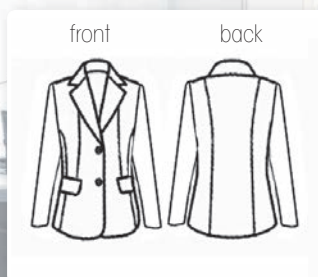

FITTED

J235 - FASHION JACKET

One Button Long sleeve jacket, with mock pockets

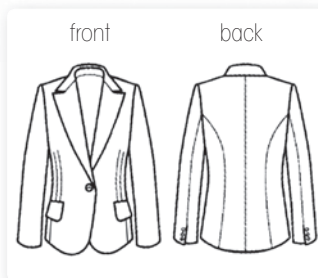

PROFESSIONAL PANTS



Our Fabric
STRETCHES!
Superior Quality
Spandex Suiting

B220 - EMPIRE LINE SHIRT
3/4 Sleeve Blouse with
Bias Fronting

E60 - PIN-TUCK PANTS
Two Pocket, Button Front
Pants with Waistband detail
and Pin Tucks

B610 - FASHION BLOUSE
3/4 Sleeve with Button Front Blouse
with Functional Pockets

E69 - BELTED PANTS
Wide Waistband Pants with Lined
Pockets and Belt

WEAR THE PANTS



FITTED

E60 - PIN-TUCK PANTS
Two Pocket, Button Front
Pants with Waistband
detail and Pintucks

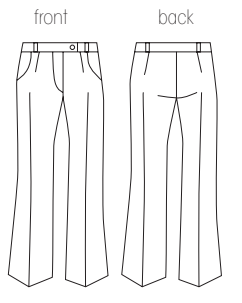

FITTED

S150 - SLIM-FIT PANTS
Slim fit, slightly dropped
waist, no waistband

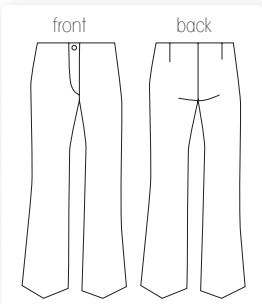

FITTED

E85 - Pants
Back elastic pants
with 2 pockets

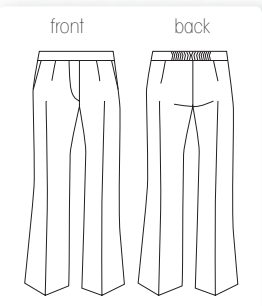



Our **BEST SELLER**
Superior Quality
Spandex Suiting

CLASSIC

E64 - EXTENDED WAISTBAND PANTS
Extended Waistband Pants
with Pockets

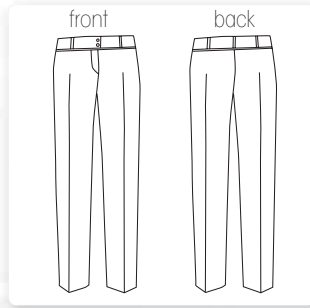

RELAXED

E69 - BELTED PANTS
Wide Waistband,
Pants with Lined Pockets
& Belt



CLASSIC

E82 - BUTTON FRONT PANTS
Button front basic
Pants & Pockets

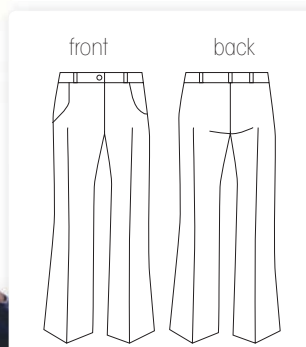

HARD AT WORK SKIRTS



B610 - FASHION BLOUSE
3/4 Sleeve Button Front
Blouse with Functional Pockets

C86 - KNIFE PLEAT SKIRT
Over-knee pencil line skirt with
Knife pleat detail





CLASSIC



C412 - SHORT LENGTH

SKIRT

Pencil line skirt with back vent & belt

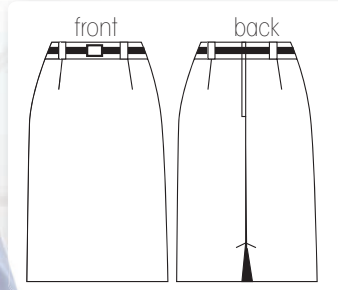

RELAXED

C409 - INVERTED PLEAT

SKIRT

Soft shaped knee length skirt with waistband and inverted pleats

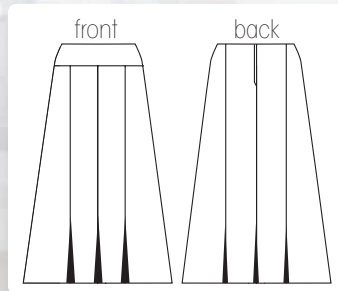

RELAXED

C84 - SWIRL SKIRT

Knee length swirl skirt

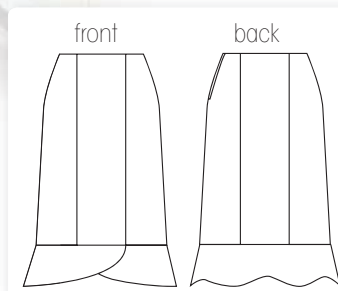

SKIRTS



CLASSIC

C86 - KNIFE PLEAT SKIRT

Over-knee pencil line skirt with knife pleat detail

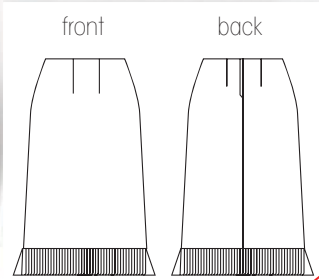

RELAXED

C460 - FLARED SKIRT

Knee length flared panel skirt

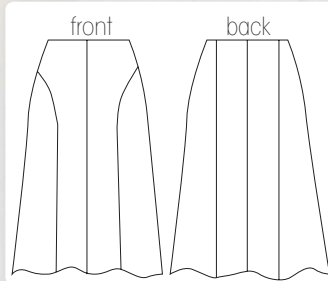

CLASSIC

C97 - DOUBLE INVERTED SKIRT

Knee length, pencil line skirt with 4 inverted front pleats & belt

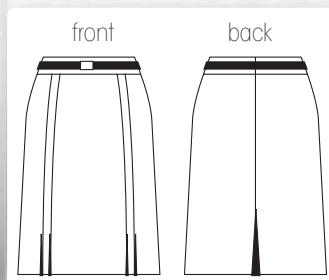

SKIRTS



FASHION

C115 - BUTTON SKIRT

Knee length pencil line skirt with side pleat and 7 button detail.

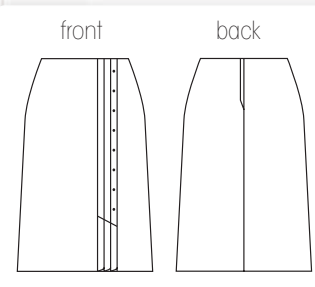

CLASSIC

C327 - PANEL SKIRT

Long length flare skirt with waistband

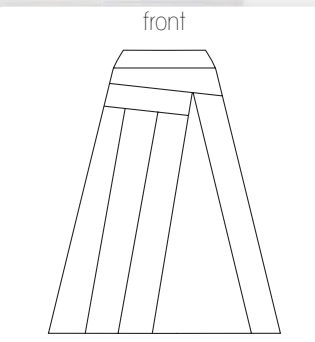

FASHION

C160 - CHURCH SKIRT

Long length, fully lined skirt with chain belt

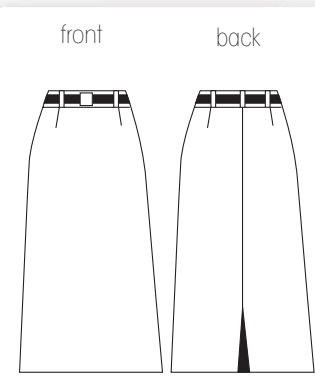

SKIRTS

Our
BEST SELLER
Superior Quality
Spandex Suiting



FITTED

C238 - PENCIL SKIRT

Pencil line knee length skirt with back vent and Belt

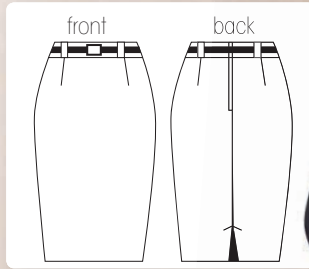

FITTED

C241 - INVERTED PLEAT BELOW KNEE SKIRT

Knee length pencil line skirt with 2 front inverted pleats, back slit with belt

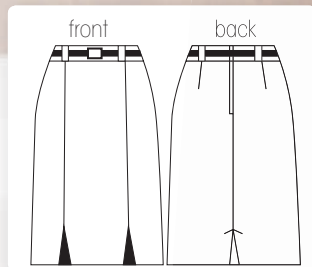

FITTED

C248 - INVERTED PLEAT ABOVE KNEE SKIRT

Above the Knee pencil line skirt with 2 front inverted pleats with back slit & belt

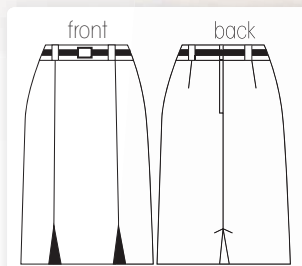

SKIRTS



Our **BEST SELLER**
Superior Quality
Spandex, Lining

CLASSIC

C410 - INVERTED PLEAT SKIRT

Knee Length Skirt with 6 Inverted Pleats and Belt

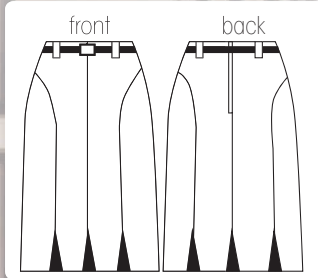

CLASSIC

C368 - KNIFE PLEAT SKIRT

Knee Length Pencil Line Skirt with Knife Pleat Detail

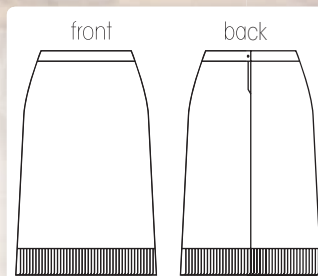

FASHION

C310 - FRINGE SKIRT

Knee Length Skirt with side Knife Pleat detail and Belt

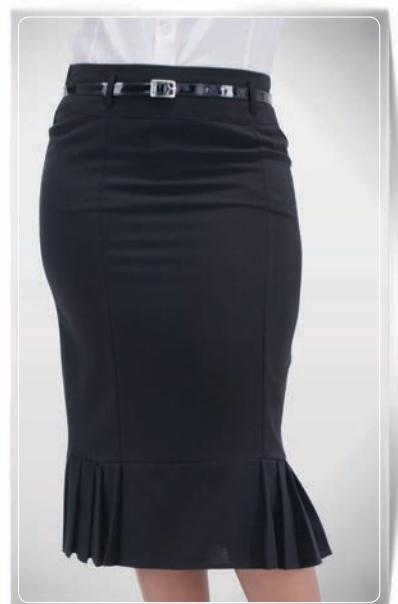
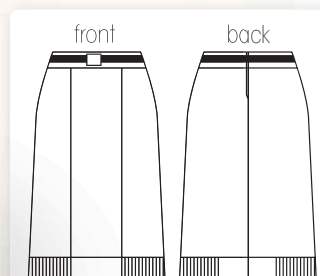

DRESSES OF SOPHISTICATION



CLASSIC

D158 - KNIFE PLEAT DRESS

Sleeveless Knee Length
Shift dress, with knife-pleat
detail and belt

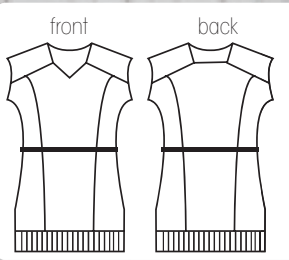

FASHION

D90 - PETER PAN DRESS

Sleeveless knee length Shift
dress with Peter-pan Collar, front
Pleat detail and belt

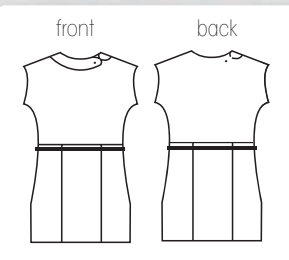

SHIFT DRESSES

Our BEST SELLER
Superior Quality Spandex Suiting



CLASSIC

D121 - V-NECK DRESS

Cap Sleeve knee length
Shift dress, with belt

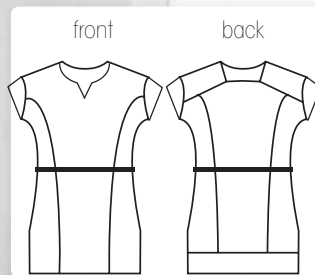

FITTED

D34 - COWL NECK DRESS

Cap Sleeve Knee length
shift dress with cowl
neck & belt

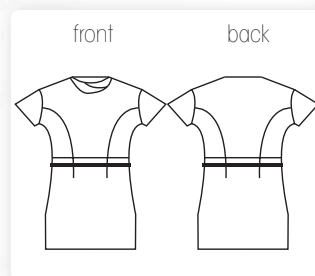



BOBAT

LADIES CORPORATE & HIGH FASHION MANUFACTURERS

Yousuf Bobat Trust
t/a

BOBAT WHOLESALERS

Reg No.: IT164/04 Vat: 4880211141

1st Floor Bobat Centre, 38 Carlisle Street, Durban, 4001
Tel: 031-309 4089 Fax: 031-309 2700 Cell: 084 666 7863

e-mail:sales@bobatwholesalers.co.za • iyb@bobatwholesalers.co.za
admin@bobatwholesalers.co.za

IN ORDER TO STREAMLINE OUR SERVICES AND PREVENT DELAYS, KINDLY
SPEND TIME FAMILIARISING YOURSELF WITH THESE TERMS AND CONDITIONS
CONCERNING PURCHASE, DELIVERY AND PAYMENT.

IN ORDER TO AVOID DELAYS, PLEASE BE PREPARED TO MAKE A
CONSOLIDATED PAYMENT WHEN WE ADVISE YOU THAT YOUR
GOODS ARE READY FOR DELIVERY.

THE ORDER PATH

- All orders should be placed with the help and approval of a co-ordinator.
- Signed and dated orders are to be received by BOBAT Wholesalers head office.
- After your order has been processed, you will receive an "order confirmation" which must be checked against this order. Any discrepancies must be faxed to us immediately for correction.
- If we have not commenced production we can accept amendments to orders but this will probably result in a delay in delivery.
- We will notify you by fax when your order is ready for delivery so that you can make payment. Payment must be made within 3 days of notification directly into the bank account of Bobat Wholesalers. The relevant details of such bank account will be furnished to you when we request payment.
- Once payment is received we will despatch your order directly to you by your nominated transport co. to the physical address entered on the order form.
- Please ensure that your correct physical address and its relevant postal code, as well as address, fax number and e-mail address are entered in the spaces provided on the order form.
- Our head office will be happy to assist with any queries but initially all queries should be handled by the co-ordinator with the agent.
- Should it be necessary to return garments please contact your co-ordinator who in turn will contact your agent for detailed instructions.

AGENT

1. PRICE

- 1.1 The Price Quotes are exclusive of VAT and transport.
- 1.2 The Prices are valid only in respect of orders completed, signed and received by Bobat Wholesalers.
- 1.3 Notwithstanding the provisions of paragraph 1.2 hereof, Bobat Wholesalers shall have the right to alter the Prices, prior to such validity date, such alteration as a consequence of changes in the rate of duty and/or fluctuations in the rate of exchange of the Rand/Dollar.

2. PAYMENT

- 2.1 Payment of the Agreed Price, as more fully reflected on the order, shall be payable, in cash, by you, to Bobat Wholesalers, In full, within 3 (three) working days of receipt of notification from Bobat Wholesalers that the Order is ready for delivery.
- 2.2 Payment of such agreed price shall be made directly by you into our Bank Account, the details of which shall be supplied to you together with the requisite notification aforementioned.
- 2.3 In the event of your failing to pay on or before due date, any monies owing to Bobat Wholesalers in terms of this Agreement, then and in such an event Bobat Wholesalers shall have the right to suspend delivery of the Goods, where applicable, until all sums, then outstanding, have been paid to Bobat Wholesalers by you.

2.4

- 2.4.1 Should you cancel this Order or refuse to make payment when advised, for whatever reason, Bobat Wholesalers shall be entitled, in its sole and absolute discretion, to charge you a Cancellation Fee of an amount equivalent to 25% (TWENTY FIVE PERCENT) of the Agreed price.
- 2.4.2 This Cancellation Fee shall become due and payable by you to Bobat Wholesalers when you have advised Bobat Wholesalers in writing that you wish to cancel the Order or are unable to fulfil the payment conditions.
- 2.5 A 50% deposit must accompany this order if requested by Bobat Wholesalers. This order will only be processed on receipt of the deposit.

3. OWNERSHIP

Ownership shall remain vested in Bobat Wholesalers and shall not pass to you until such time as you have made payment in full to Bobat Wholesalers for the Goods.

4. DELIVERY

- 4.1 Delivery of the Goods shall only be affected once this (complete) Order is ready for delivery and, above all, payment in full has been received by Bobat Wholesalers from you.
- 4.2 Bobat Wholesalers shall use its best endeavours to adhere to specified delivery dates, but shall not be bound by such dates, and accepts no liability for any loss, expense, consequential or any other damages, of whatsoever nature and howsoever arising, that may result from any delay in delivery.

5. RELEASE

- 5.1 Bobat Wholesalers shall be irrevocably released from the obligation to manufacture and/or sell and/or deliver any particular item of this Order if, for any reason whatsoever and howsoever arising, it is unable to supply and/or deliver same, and in which event, Bobat Wholesalers shall not be liable to you for any loss of profit or damages, direct or indirect, consequential or otherwise.
- 5.2 Such release to which reference is made in paragraph 5.1 hereof, shall in no way effect or detract from your obligation to pay, per the provisions of paragraph 2 above, for all the remaining terms, reflected in this Order, that are manufactured and ready for delivery.

6. RISK

- 6.1 Notwithstanding the reservation of ownership as set out above, all risk in and to the Goods shall pass to you once the Goods have been signed for by you / your co-ordinator or a designated official, to the carrier who has been appointed to deliver same to you.
- 6.2 All costs, directly or indirectly, incurred by Bobat Wholesalers in storing the Goods, after the date upon which you were due to have collected same, shall be paid by you to Bobat Wholesalers at prevailing market related storage rates, this against your said collection of the goods from the premises of Bobat.

7. ALTERATIONS

- 7.1 The sizes and lengths of the garments, as per fit samples, constitute the only sizes and lengths that are manufactured as part of the Bobat Wholesalers range, and accordingly no exceptions will be made in the event of such size or length not matching your personal needs and requirements.
- 7.2 Notwithstanding the provisions of 7.1 hereof, if it should be that any particular garment is an inappropriate size or length, then Bobat Wholesalers is prepared to make the necessary arrangements for the requisite fabric to be purchased by you, in order to satisfy such personal requirements.

8. CONTINUITY OF STYLES AND COLOURS

Notwithstanding that it is Bobat's objective to provide a continuity of styles and colours, this with regard to the range, this is subject to the following exceptions:

- 8.1 Colour variations may occur as a consequence of different dye-lots of fabric;
- 8.2 Changes of style with regard to existing garments may be introduced, without notice, from time to time, by Bobat Wholesalers, this in order to uphold its standard of manufacture;
- 8.3 Bobat Wholesalers shall have the right, without notice, from time to time, to withdraw or modify its styles, fabrics and colours.

9. ACCESSORIES

The accessories, other than Scarves, that are depicted in the requisite Brochure, in respect of the Range, do not form part of this Order and are therefore for marketing purposes only.

10. EXCHANGES

- 10.1 Bobat Wholesalers will exchange goods that are delivered, to you in a defective state, subject however to the following conditions:
 - 10.1.1 Notice of such defect(s) must have been given to Bobat Wholesalers in writing by you within 7(SEVEN) days of the date of delivery of such goods.
 - 10.1.2 Subject to the provisions of paragraph 10.1.1 hereof, such goods must be returned to Bobat Wholesalers by you together with the original swing ticket, plastic bag and hanger.
 - 10.1.3 Bobat Wholesalers reserves the right to determine whether or not the garment is of a defective nature.
- 10.2 In the event of there being any claim on your part for shortages as a consequence of incomplete delivery.
- 10.3 The onus is on the customer to ensure they order the correct size garments. Where you have fitted a garment that requires an exchange for sizing, Bobat Wholesalers will charge a handling fee of R150 per garment.
- 10.4 In as much as each garment is delivered with detailed care instructions, and which care instructions are attached to the garments themselves, Bobat Wholesalers shall not be responsible for any damage that may be caused to the garments due to your incorrect laundering or general poor care.

11. AUTHORISED CO-ORDINATORS

- 11.1 Where applicable, orders must be approved and signed by the Authorised Co-ordinator.
- 11.2 In such circumstances, all communications, queries, and the like, that you may have, with regard to any aspect pertaining to the Goods, this Order and/or this Order Form, must be directed through the offices of the Authorised Co-ordinator.

12. STANDARDISED ORDERING

In as much as the Order Forms are standardised, Bobat Wholesalers cannot, without exception, accept any special instructions or requests that may be added to the Order Form, and accordingly any such special instructions or requests will be rejected by Bobat Wholesalers and thus deemed to be "pro non scripto".

13. "VIS MAJEURE"

Should Bobat Wholesalers be prevented from the performance of any of its obligations as a result of forces beyond its control, an within that ambit, of any cause whatsoever and howsoever arising, Bobat Wholesalers shall be entitled, as its option, to cancel this Agreement or to suspend performance of its obligations thereunder and shall not be liable for any loss or damage, consequential or otherwise resulting from such cancellation.

14. BREACH

- 14.1 Should you be in breach of any of the terms of this Agreement, alternatively should you fail to make payment, on due date, of any monies owing, by you to Bobat Wholesalers, Bobat Wholesalers shall be entitled, without prejudice to any other rights which it may have, in law, to forthwith cancel this Agreement, without any notice to you and claim from you any damages it may have suffered as a result of such breach.
- 14.2 Notwithstanding the content of paragraph 14.1 hereof, Bobat Wholesalers shall be entitled to claim specific performance together with a concomitant claim for such damages as it may have suffered as a result of such breach.
- 14.3 If applicable, and prior to circumstances where you are in breach of this Agreement, Bobat Wholesalers shall be entitled to retain any monies paid by you to it prior to the date of such breach and which monies you accordingly, and in terms hereof agree to forfeit to Bobat Wholesalers.
- 14.4 In the event of you being in breach of any of the terms of this Agreement, alternatively, should you fail to make payment, on due date, of any monies owing by you to Bobat Wholesalers, then, in any one of those events, and should it be necessary, for Bobat Wholesalers, to instruct attorneys in terms hereof any legal costs should be incurred, then you shall be liable to Bobat Wholesalers for payment of all such legal costs, this on the scale as between attorney and own client, and also, all collection charges incidental thereto.
- 14.5 Where applicable, payments made in respect of any, indebtedness by you to Bobat Wholesalers shall be appropriated first to the costs (attorney and own client) incurred, to collection charges, thereafter to interest and finally to the reduction of capital.

15. DOMICILUM

You hereby choose as your 'domicilium citandi et executandi', for all purposes in connection with or arising out of this Agreement, the physical address as reflected on the order copy.

16 JURISDICTION

- 16.1 You agree that any Magistrate's Court which has jurisdiction over your person, shall have jurisdiction to entertain any action or proceedings that may arise out of the sale and/or delivery of the Goods, by Bobat Wholesalers, to you, alternatively, this Agreement, including but not limited to the payment of any amount, notwithstanding that the amount of such claim may exceed the statutory jurisdiction of such Court, and you hereby consent to such jurisdiction as contemplated in Section 45 of Act 32 of 1944, as amended.
- 16.2 Nothing herein contained shall ever preclude Bobat Wholesalers from instituting any action against you in the appropriate division of the High Court of South Africa.

17. REPRESENTATIVE CAPACITY

In the event of the signatory hereto, other than the Authorised Co-ordinator, being the representative of a company, alternatively a close corporation, whichever the case may be, such signatory who signs in such representative capacity specifically represents that he/ she is an authorised signatory, and that he/she warrants that he/ she is duly authorised to sign, as aforesaid, and to bind the company, alternatively, the close corporation, whichever may be the case.

18. SURETY AND CO-PRINCIPAL DEBTOR

The aforesaid signatory referred to in paragraph 17 hereof, hereby binds himself as surety and co-principal debtor, "in solidum", unto and in favour of Bobat, for payment, on demand of all sums of money which may at any time be owing to you by Bobat Wholesalers from whatsoever cause arising, which sums shall include all interest and any other charges (inclusive of costs on the attorney and own client scale), which you may, from time to time, become liable to pay to Bobat.

19. CERTIFICATE OF INDEBTEDNESS

A certificate, by any of the directors of Bobat Wholesalers, certifying a balance outstanding at any time, shall be 'prima facie' proof that such balance is due, owing and payable by you to Bobat Wholesalers and shall be sufficient for the purposes of enabling Bobat Wholesalers to obtain summary judgement or an order for provisional sentence against you and/or the Authorised Co-ordinator, in terms hereof.

20. INTEREST

All amounts owing by you to Bobat Wholesalers in terms hereof, and which are overdue shall bear interest at the rate of 2% above the prime bank overdraft rate, from time to time charged by the First National Bank, to its preferred customers, and which interest shall run with effect from due date until date of final payment.

21. NON-VARIATION

No amendments, variations, additions, alterations, or consensual cancellation of the Order and/or this Order Form and/or the Agreement and/or any provisions hereof shall be any force or effect unless recorded in a written document and signed by all parties here to.

22. NON-WAIVER

No waiver of any of the terms and conditions of this Order and/or this Order Form and/or this Agreement will be binding, for any purpose, unless expressed, in writing, and signed by the party giving same and any such waiver will be effective only in the specific instance and for the purpose given and no other.

23. ENTIRE AGREEMENT

This offer (and Bobat Wholesalers' written order confirmation), constitutes the entire agreement between the parties and there are no understandings, agreements, warranties or representations other than those set out in writing herein.

24. Bobat Wholesalers cannot be held responsible for any misleading or erroneous information published in this catalogue.

J525 - LINED JACKET

Lined cuffs, Two Button
Fashion Jacket, with 2 mock
pockets, 1/2 lined body

B1008 - TIE-UP COLLAR BLOUSE

Short Sleeve Blouse with Tie-up
detail



D90 - PETER PAN DRESS

Sleeveless knee length Shift dress with Peter-pan Collar, front Pleat detail and belt